

# aiwa

COMPACT  
disc  
DIGITAL AUDIO

OPERATING INSTRUCTIONS  
MANUAL DE INSTRUCCIONES  
MODE D'EMPLOI

## ADC-M105 YU

COMPACT DISC CHANGER  
CAMBIADOR DE DISCOS COMPACTOS

ENGLISH

ESPAÑOL

FRANÇAIS

### OWNER'S RECORD

For your convenience, record the model number and serial number (you will find them on the rear of your set) in the space provided below. Please refer to them when you contact your AIWA dealer in case of difficulty.

Model No.

Serial No.

8Z-KM3-922-01  
001110ATM-OX

# Welcome

Thank you for your purchasing this AIWA product. To optimize the performance of this unit, please read through this manual carefully.

---

## TABLE OF CONTENTS

FEATURES .....	1
PRECAUTIONS .....	2
UNPACKING .....	3
INSTALLATIONS .....	4
CONNECTIONS .....	8
HOW TO USE .....	9
SPECIFICATIONS .....	10

---

## FEATURES

- Tracks from 10 CDs stored in the disc magazine can be selected and played.
- Horizontal, vertical, slanted or suspended installation can be made.
- Through the window at the top of the unit, you can see a disc spinning as it plays.
- Since it is smaller in size, you will find it easier to install the unit.

### NOTE

This equipment has been tested and found to comply with the limits for a Class B digital device, pursuant to Part 15 of the FCC Rules. These limits are designed to provide reasonable protection against harmful interference in a residential installation.

This equipment generates, uses, and can radiate radio frequency energy and, if not installed and used in accordance with the instructions, may cause harmful interference to radio communications. However, there is no guarantee that interference will not occur in a particular installation. If this equipment does cause harmful interference to radio or television reception, which can be determined by turning the equipment off and on, the user is encouraged to try to correct the interference by one or more of the following measures:

- Reorient or relocate the receiving antenna.
- Increase the separation between the equipment and receiver.
- Connect the equipment into an outlet on circuit different from that to which the receiver is connected.
- Consult the dealer or an experienced radio/TV technician for help.

### CAUTION

Modifications or adjustments to this product, which are not expressly approved by the manufacturer, may void the user's right or authority to operate this product.

In addition to ordinary CDs, CD-Rs or CD-RWs can be read by this unit. However, NEVER use a CD-R or CD-RW that contains no data or data in the wrong format, such as MP3 or other computer files.

When you insert a CD-R/CD-RW, it may take longer to start playing.

# PRECAUTIONS

- Do NOT install the unit in a location where it may be subjected to:
  - Direct sunlight or other sources of excessive heat
  - Fluid, rain or moisture
  - Excessive dirt or dust
  - Excessive vibration
- This unit is designed to be operated on a 12-volt DC negative-ground electrical system only.
- Choose the mounting location carefully so that the unit will not interfere with normal driving functions.
- Before making connections, disconnect the  $\ominus$  terminal of the car battery to avoid short circuiting.

## Notes on CDs

- A defective or soiled disc stored in the disc magazine can cause the sound to drop out during play.
- Always handle a disc by holding its inner and outer edges.

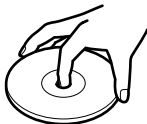

- Do NOT touch the surface of the unlabeled side of the disc.
- Do NOT attach paper or tape etc. to a disc.



- Do NOT expose the discs to direct sunlight or excessive heat.



- Clean the discs before inserting them into the disc magazine. Always clean a disc from the center outward with a cleaning cloth.



- There may be burrs left on the inner and outer edges of a brand-new disc. The burr may cause the malfunction of the unit or sound drop-out. To prevent these problems, if the burr is left on the disc, be sure to remove them with a ball-point pen, etc. as illustrated.

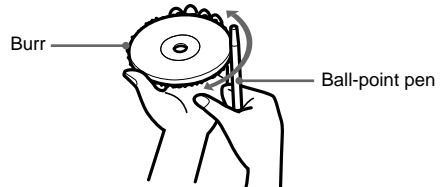
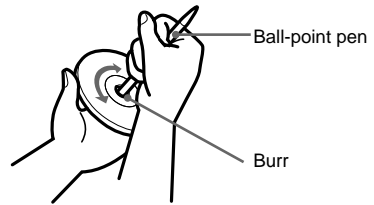

- NEVER use solvents such as benzine or alcohol to clean a disc.
- You cannot play an 8-cm (3-inch) CD — even with the specially designed adaptor.
- Do NOT use irregular shape CDs (example: heart-shaped, octagonal ones). It may result in malfunction.

## Notes on the disc magazine

- Do NOT leave the disc magazine in a place subject to excessive temperature or humidity.
- Do NOT insert more than one disc per slot.
- Do NOT drop the disc magazine.

# UNPACKING

Compact disc changer

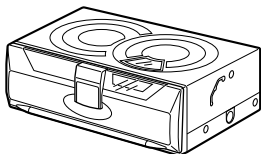

Compact disc magazine

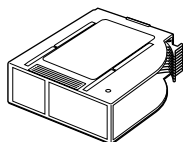

Connecting cable

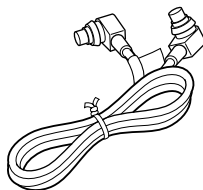

## Supplied mounting kit

for the compact disc changer

The letters are keyed to those in the instructions.

Use only the supplied mounting hardware for safe and secure installation.

a Brackets (1 pair)

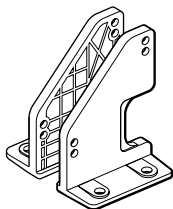

b Washer screws (4 ea.)



c Plate brackets (2 ea.)

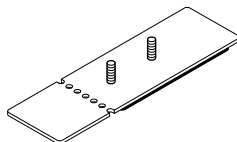

d Nuts (4 ea.)



e Adhesive label (1 sheet)

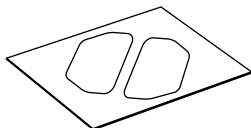

# INSTALLATIONS

## Precautions

Select the mounting location very carefully, referring to the following points.

- Make sure that there is no fuel tank, wiring or piping on the other side of the mounting surface.
- Make sure that the installation of the unit will not hinder the movement of the deck lid or interfere with the spare tire, etc.
- Use only the supplied mounting kit for safe and proper installation.

## Removing the transport screws

Find the three transport screws at the bottom of the unit, which lock the unit's mechanism during transport. Remove these screws before installation.

Retain these screws and replace them in the original positions if the unit is transported for service or maintenance.

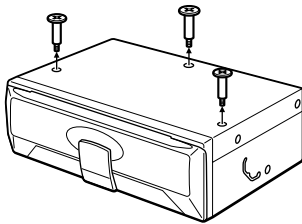

## Mounting angle setting levers

Be sure to change the position of both mounting angle setting levers according to the angle at which the unit is to be installed.

Mounting angle setting levers

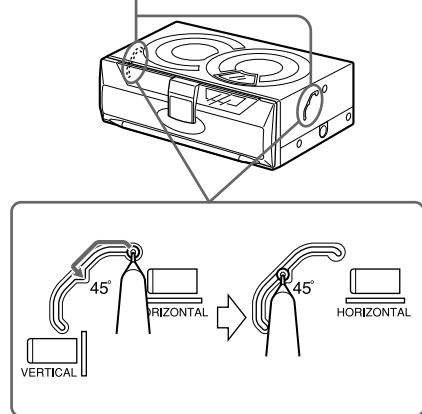

Insert a pointed object such as a screw driver or ball-point pen, etc. into the low spot of the lever and slide the lever to the position from among HORIZONTAL, 45°, and VERTICAL positions.

## Notes

- Be sure to eject the disc magazine when you set the levers.
- Be sure to set both levers to the same position.
- Be sure to set the levers exactly at the position (notch). If the lever is deviate from the position, the sound may drop out.
- Care must be taken when you mount the unit at the angle of lower than level. The disc magazine may drop if you eject the magazine.
- Do NOT turn over the unit or slide the lever when the unit is activated. Doing so may damage the mechanism or the discs in the unit.
- The mounting angle setting levers on each side of the unit are factory-set to the HORIZONTAL position.
- When you complete the setting, attach the supplied adhesive labels (E) over the slots.

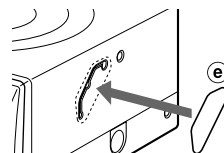

# INSTALLATIONS

## Horizontal installation

### 1 Construction

For details on (a)(b)(c)...., see page 3.

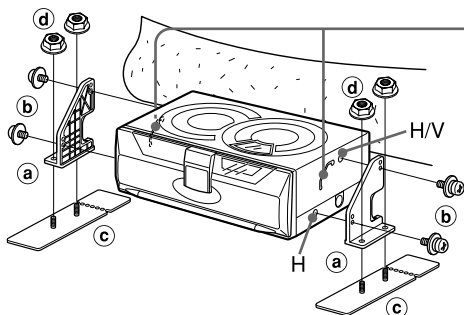

The effective angle of the unit.

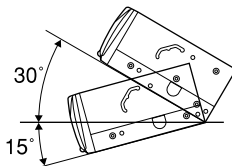

The position of the lever.

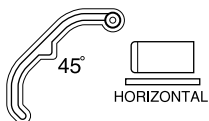

#### Note

If the mounting surface needs to be strengthened, secure the plate brackets (c) to the bottom surface of the car trunk, etc. with the tapping screws (not supplied).

### 2 Deciding the position

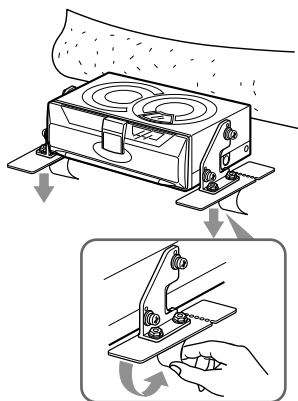

### 4 Making holes in the carpet

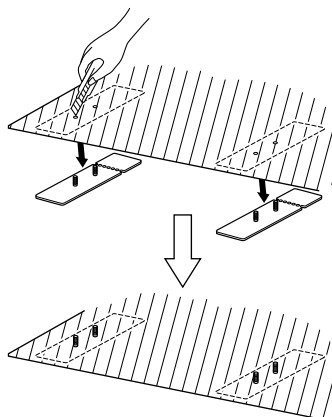

### 3 Removing temporarily

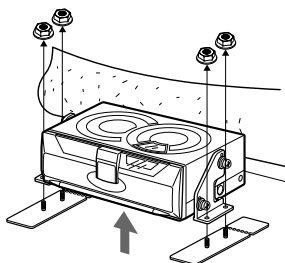

### 5 Completion

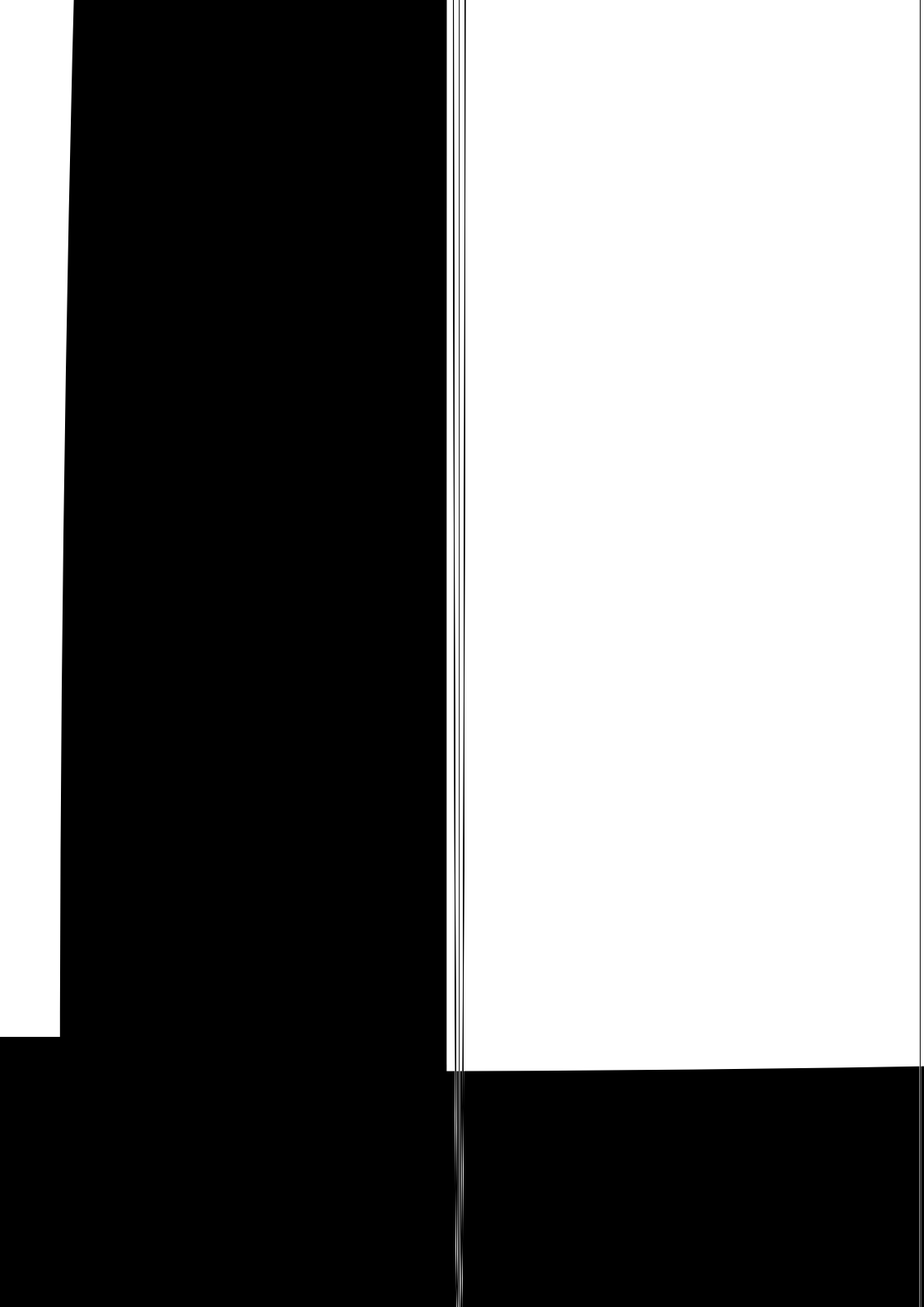

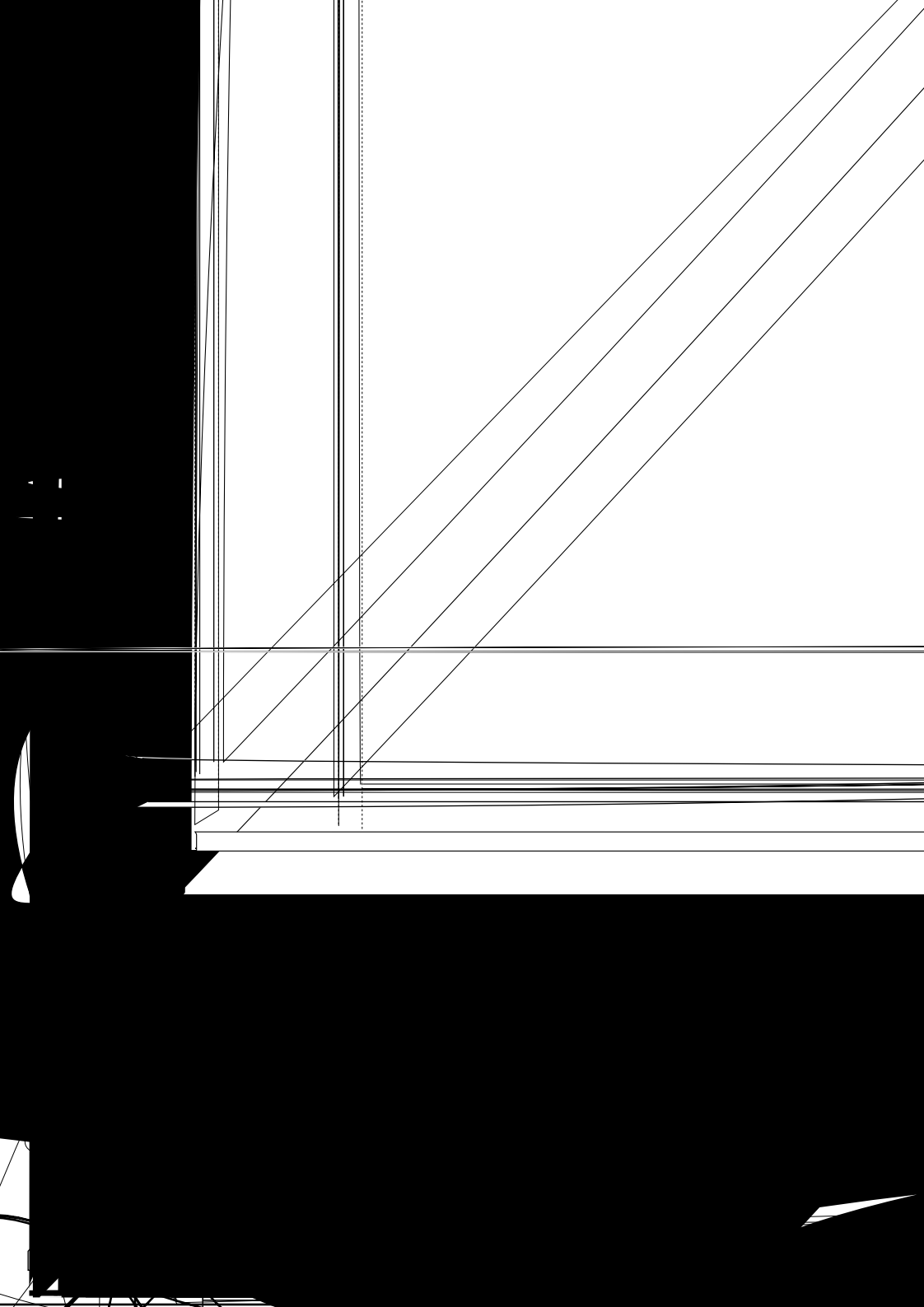



# CONNECTIONS

This unit is designed only for AIWA brand car stereo. Therefore you cannot use the unit with other brand's equipment.

## Compact disc changer

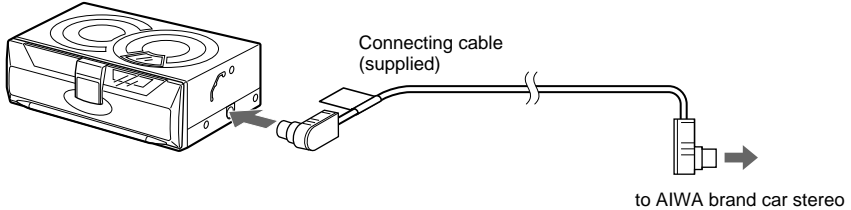

## Caution

Be sure to disconnect the ground wire terminal of the car battery before making a connection in order to prevent short circuiting.

## Note

Use only the supplied connecting cable. Using an unspecified connecting cable may cause background noise.

# HOW TO USE

## How to use a compact disc magazine

1

With the label side up, insert a disc all the way.

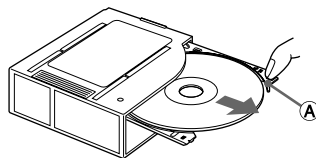
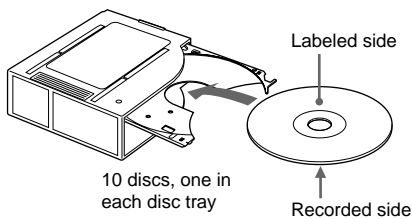

To remove a disc, pull part **A** in the direction of the arrow as illustrated.

2

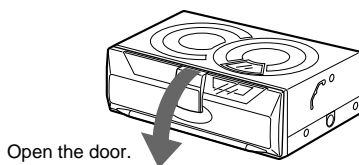

Open the door.

3

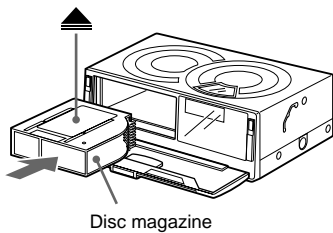

Insert the magazine (which has been taken out of the unit) firmly with the **▲** mark visible on the top side.

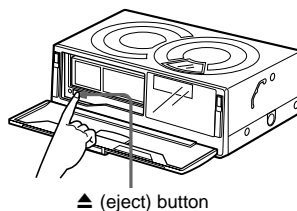

To remove the magazine, press the **▲** button and pull out the disc magazine.

4

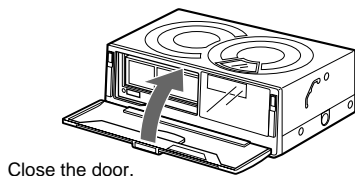

Close the door.

# SPECIFICATIONS

## Notes on the disc magazine

- Be sure to place a disc on the disc tray with the label side up. If a disc is not set properly, it may cause damage to the unit.

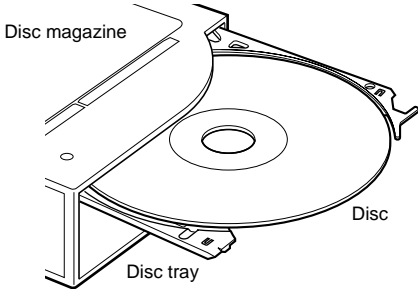

- The disc tray may be taken off from the magazine if you pull the tray forcibly. If the tray is taken out, put it back into the magazine as illustrated. Be sure that both ends of the tray are aligned to the grooves of the magazine correctly.

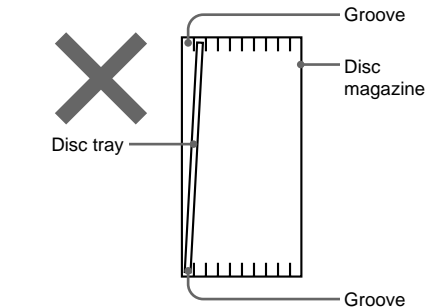
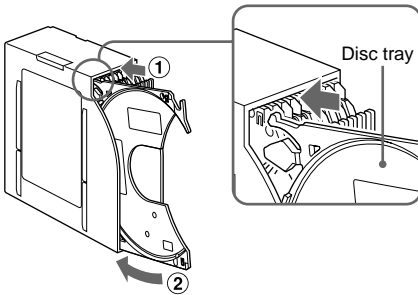

- Be sure all the trays are set in the magazine when using the unit.

## Compact disc changer

System	Compact disc digital audio system
Frequency response	5 Hz – 20 kHz
Wow and flutter	Below measurable limit
Signal to noise ratio	91 dB or more
Outputs	Line output (for changer connector only)
Operating temperature	–10 °C to 55 °C
Dimensions	254 × 83 × 173 mm (w/h/d) (10 × 3 3/8 × 6 7/8 in.)
Weight	2.1 kg (4.62 lbs.)
Power requirement	12 V DC car battery (negative ground)
D/A converter	1 bit DAC, 8 times over sampling
Sampling rate	44.1 kHz
Disc size	120 mm
Supplied accessories	Disc magazine (1) Mounting kit (1 set) Connecting cable (5 m) (16.4 ft.) (1)

Design and specifications are subject to change without notice.

